

Occupancy Plus Sensor

Instruction Manual



MSMW24-BP.11

Before using this product, please read this manual carefully and keep it properly!

Document Version: C



◆◆ Overview

Occupancy Plus Sensor (hereinafter referred to as the "product" or "device") adopts 24GHz millimeter wave radar technology and advanced human detection algorithm, integrating with human presence sensor, illuminance module, temperature detection module and two dry contact input function. This product is suitable for detecting human presence, monitoring illuminance and real-time temperature, as well as switch controlling. Upon proper installation and commissioning, end users can proceed linkage control between this product and other intelligent devices through mobile phone App.

Key Functions:

- HDL Buspro communication protocol
- Human presence detection: 24GHz millimeter wave radar technology, accurate and high sensitivity for detecting human motion and breath
- Illuminance monitoring: Real-time illuminance can be detected by the device, providing smart scene control in accordance with actual illuminance.
- Temperature monitoring: Built-in temperature sensor for monitoring real-time environment status.
- The device is equipped with local logic module, compatible with comprehensive logic judgment through human presence detection, temperature & illuminance monitoring, external dry contact signals, general switches, etc.
- Master / slave logic setting: After setting, it can group and combine multiple sensors, providing wide range of detection.

◆◆ Appearance

This device is available in surface-mounted and flush-mounted installation styles. By default, the device is delivered in a flush-mounted form as shown in Figures 1 & 2.

Note: When installing, make sure to select the suitable bracket based on your specific requirements, as shown in Figures 3 & 4.

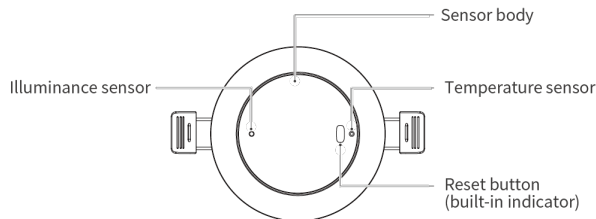

Figure 1

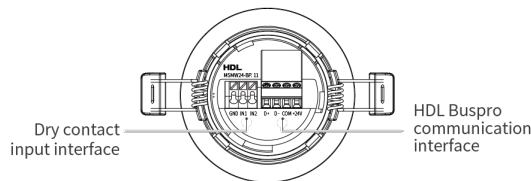

Figure 2

- Installation by the bracket (for flush-mounted)

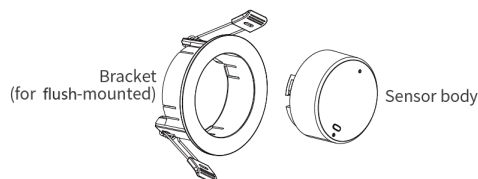

Figure 3

- Installation by the bottom cap (for surface-mounted)

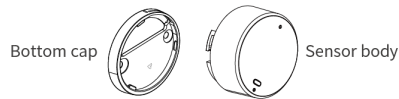

Figure 4

◆◆ Technical Data

Rated voltage	24V DC
Rated current	≤40mA/24V DC
Input voltage	12 - 30V DC
Dry contact	2 dry contacts
Communication protocol	Buspro
Cable diameter of Buspro terminal	0.6 - 0.8mm
Detection frequency for micro motion	24GHz-24.25GHz
Detection range for micro motion (in terms of diameter)	Φ6m Note: Installation height is 3m.
Sensitivity level for detection distance	The level range can be adjusted from Level 1 - 10.
Detection range for illuminance	0-1200Lux
Detection range for temperature	-20°C~60°C
Working temperature	-5°C ~ 45°C
Working relative humidity	≤90%RH, non-condensed
Storage temperature	-20°C ~ 60°C
Storage relative humidity	≤93%RH

◆◆ Specifications

Dimensions of installation for flush-mounted	Φ66 x 34.6mm (Opening size: Φ60mm, see Figure 5 & 6)
Dimensions of installation for surface-mounted	Φ48.5 x 27.5mm (see Figure 7 - 9)
Housing material	ABS
Installation	Flush-mounted (Opening size: Φ60mm, see Figure 13) Surface-mounted (see Figure 14)
Installation height (recommended)	2.5 - 3.5m
IP degree (compliant with EN 60529)	IP20

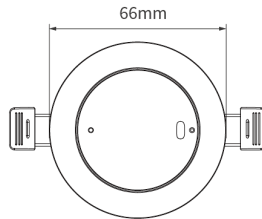
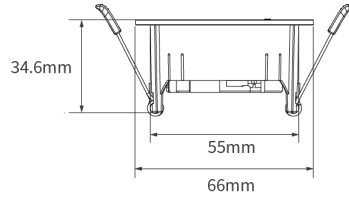

Figure 5



Note: Opening size is $\Phi 60\text{mm}$.

Figure 6

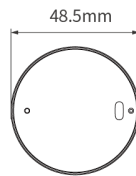

Figure 7

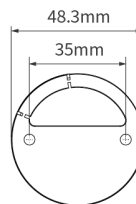

Figure 8

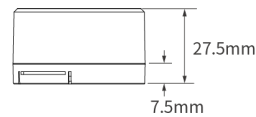

Figure 9

◆◆ Safety Precaution

Danger:

Please do not privately disassemble or replace any parts of the product. Otherwise, it may cause mechanical fault, electric shock, fire or personal injuries.

Warning:

- The installation and testing for the product must be carried out by HDL Automation Co., Ltd. (hereinafter referred to as HDL) or its appointed service agencies. The electric construction shall comply with local laws and safety regulations.
- HDL will not be responsible for any consequence caused by the inexpert or faulty installation and wiring methods, which are not in accordance with the instructions contained in this datasheet.
- Please contact HDL after-sales departments or our designated service agencies for your maintenance service. Product failures caused by private disassembly are not subject to the warranty.

Caution:

- Before performing any installation or disassembly procedures, any maintenance or cleaning procedures on the device, it is crucial to disconnect the device from all voltage sources. This step is necessary to ensure the safety of the technician and prevent any potential damage to the device.
- Do not use corrosive liquid to wipe the device body, especially the interface, so to avoid damage to the device.
- Do not wipe the device with a damp cloth.
- Prior to performing maintenance or cleaning on the device, disconnect the device from all voltage sources, to avoid electric leakage and electric shock.
- Kindly take note that the installation of the aforementioned device is recommended to be conducted in an indoor environment, with due consideration given to the avoidance of exposure to external factors such as humidity and high temperatures.

◆◆ Wiring

Tips: For Buspro connection, a hand-in-hand connection is recommended.

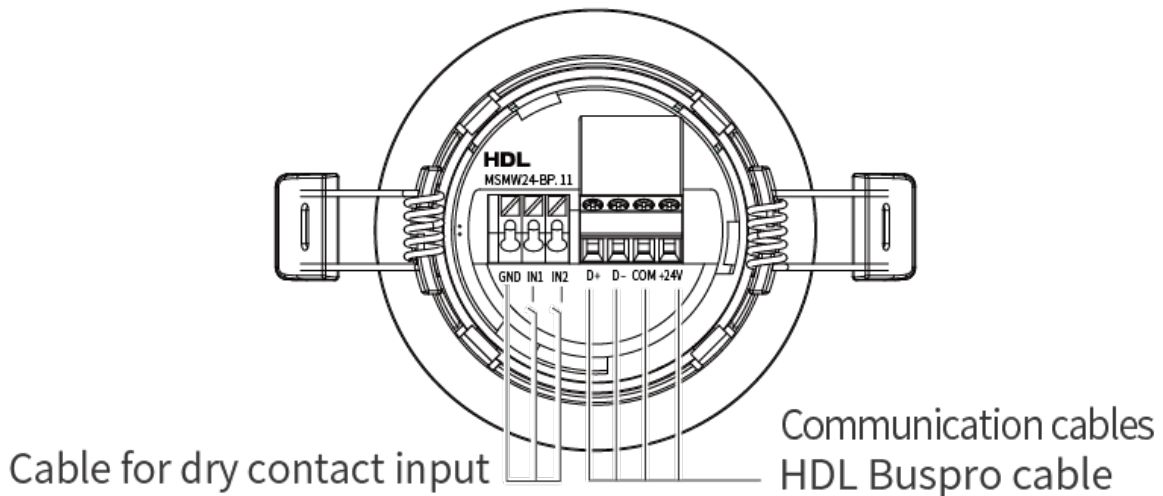

Figure 10

HDL Buspro Cable Guide

HDL Buspro	HDL Buspro Cable	CAT5 / CAT5E
DATA+	Yellow	Blue/Green
DATA-	White	Blue white/Green white
COM	Black	Brown white/Orange white
24V DC	Red	Brown/Orange

◆◆ Installation

1. Detection range

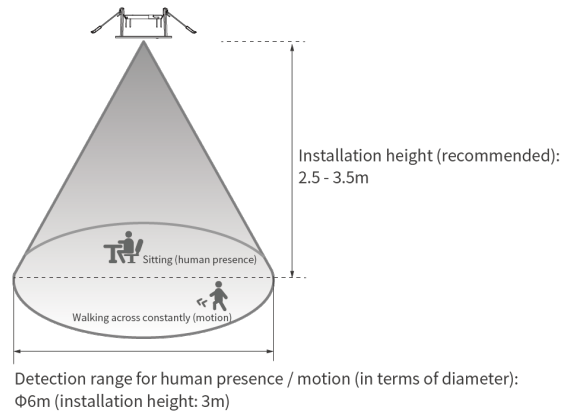

Figure 11

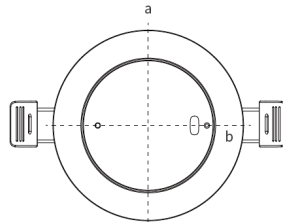

Figure 12

Note:

- The detection range of the device is oval-like, as shown in Figure 12, Edge (a) detects the short side of the diameter, Edge (b) detects the long side of the diameter, and the length of each edge varies according to different spaces and environments. The detection range can be adjusted by adjusting the installation direction of the device.
- The device can only be installed indoors. The installation site must be far away from air outlet and heat source such as air conditioner and fan, and avoid installation near large area metal objects.
- Millimeter wave band electromagnetic wave has certain penetration characteristics for non-metallic materials, which can penetrate common glass, wood, screens and thin partition walls, and can detect moving objects behind shielding objects, but can not penetrate thick load-bearing walls, metal doors and so on.
- Please keep the device away from large metal equipment, pipes, air conditioning outlets, exhaust vents, smoke exhaust machines and other scenes, so as not to affect the detection effect of equipment vibration.
- Please make sure that the device is installed securely, otherwise the device itself may move under the wind or vibration, which may lead to false alarm of human presence.
- The installation antenna face of millimeter wave radar products should not be shielded (such as chandeliers, pipes, etc.), otherwise it may affect the normal operation of millimeter wave radar products.
- The detection range data (shown in Figure 11) are for reference only and come from internal laboratory tests. There may be differences in results depending on installation environment, human presence and sensitivity.

2. Installation

The device can be mounted by the bracket (for flush-mounted) or by the bottom cap (for surface-mounted), please proceed installation as the actual needs.

Note:

- The device can only be installed indoors. The installation site must be far away from air outlet and heat source such as air conditioner and fan, and avoid installation near large area metal objects.
- Before performing any installation procedures, any maintenance or cleaning procedures on the device, it is crucial to disconnect the device from all voltage sources. This step is necessary to ensure the safety of the technician and prevent any potential damage to the device.

2.1. Installation by the bracket (for flush-mounted)

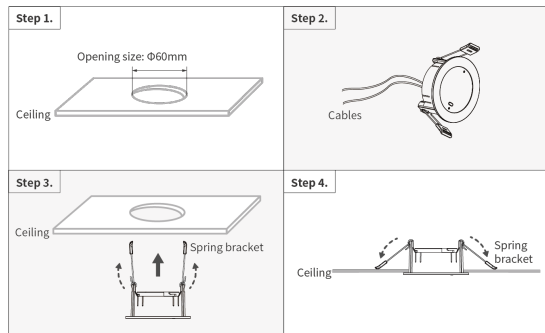

Figure 13

Step 1. Make a proper opening on the ceiling.

Note: The opening size for installation is $\Phi 60\text{mm}$; The installation height should be 2.5 - 3.5m.

Step 2. Get the necessary cables ready in the ceiling.

Step 3. Flip up the spring bracket and push the device into the opening on the ceiling.

Step 4. Flip down the spring bracket to fix the device and ensure the device is tightly attached to the ceiling.

2.2. Installation by the bottom cap (for surface-mounted)

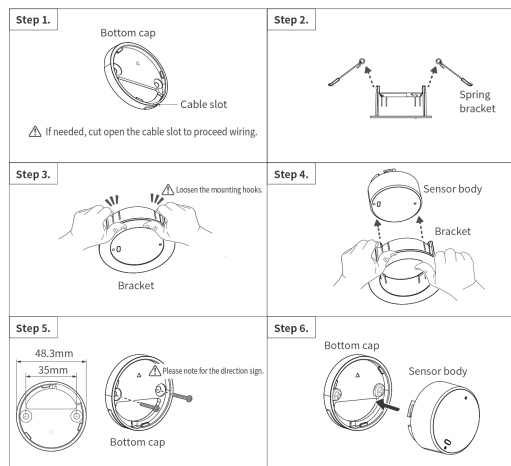

Figure 14

Step 1. Get the necessary cables ready in the ceiling. If needed, cut open the cable slot to proceed wiring.

Note: The installation height should be 2.5 - 3.5m.

Step 2. Remove the spring brackets.

Step 3. Loosen the mounting hooks.

Step 4. Push then remove the sensor body from the bracket (for flush-mounted).

Step 5. Fix the bottom cap with screws.

Note: To select suitable installation site, please refer to dimensions of the bottom cap, as well as the direction sign.

Step 6. Rotate then assemble the sensor body onto the bottom cap. Please ensure the device is tightly attached to installation site.

◆◆ Disassembly

Warning: Before performing any disassembly procedures on the device, it is crucial to disconnect the device from all voltage sources. This step is necessary to ensure the safety of the technician and prevent any potential damage to the device.

To remove the device, please refer to the reverse steps in the section **Installation**.

◆◆ Operation

The device is configured with one reset button and one indicator, as described below.

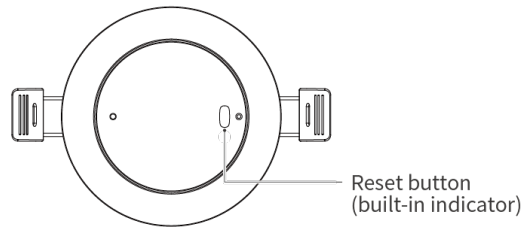

Figure 15

• Indicator

Tips: It is supported to turn off the indicator through commissioning software.

Status	Description
Make the device power-on, then the indicator slowly flashes.	Device initializing...
Green light is on.	Human presence detected
Green light flashes once at an interval of 2s.	Human presence not detected
Red light is on.	ID setting mode / Device error
Red light flashes.	Device locating mode / Device upgrading...
Off	Device is power-off. / The indicator is turned off. / Detection is disabled.

• Reset button

Function	Operation	Indicator Status	Remark
Restore factory setting	Long press for 10s	Red light is on then flashes.	Support remote operation
Modify device ID	Long press for 3s, then modify device ID through commissioning software.	Red light is on.	Support remote operation
Firmware update	Press reset button, and simultaneously connect the device to power supply.	Red light slowly flashes.	Support remote upgrade

◆◆ Commissioning

In this section, it takes Occupancy Plus Sensor (Model: MSMW24-BP. 11) as an example to show its basic setting, logic and security settings, automation and scene settings.

1. Basic Setting

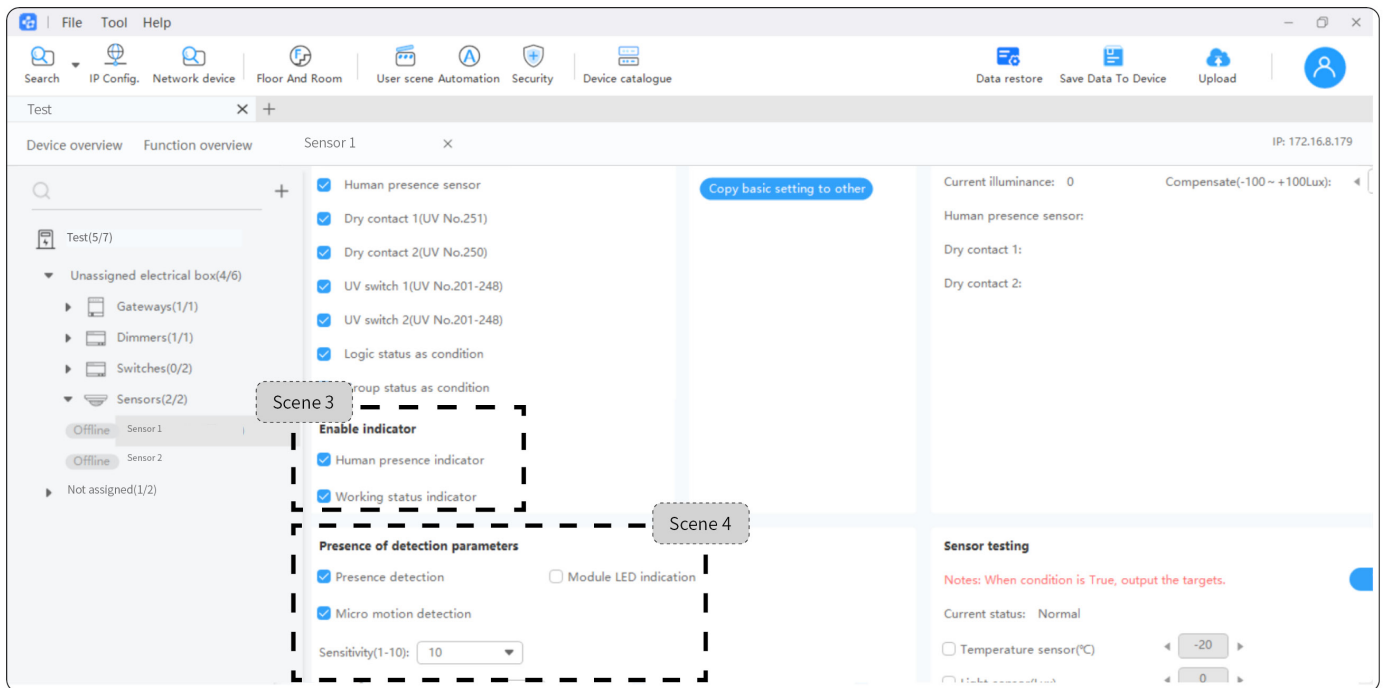
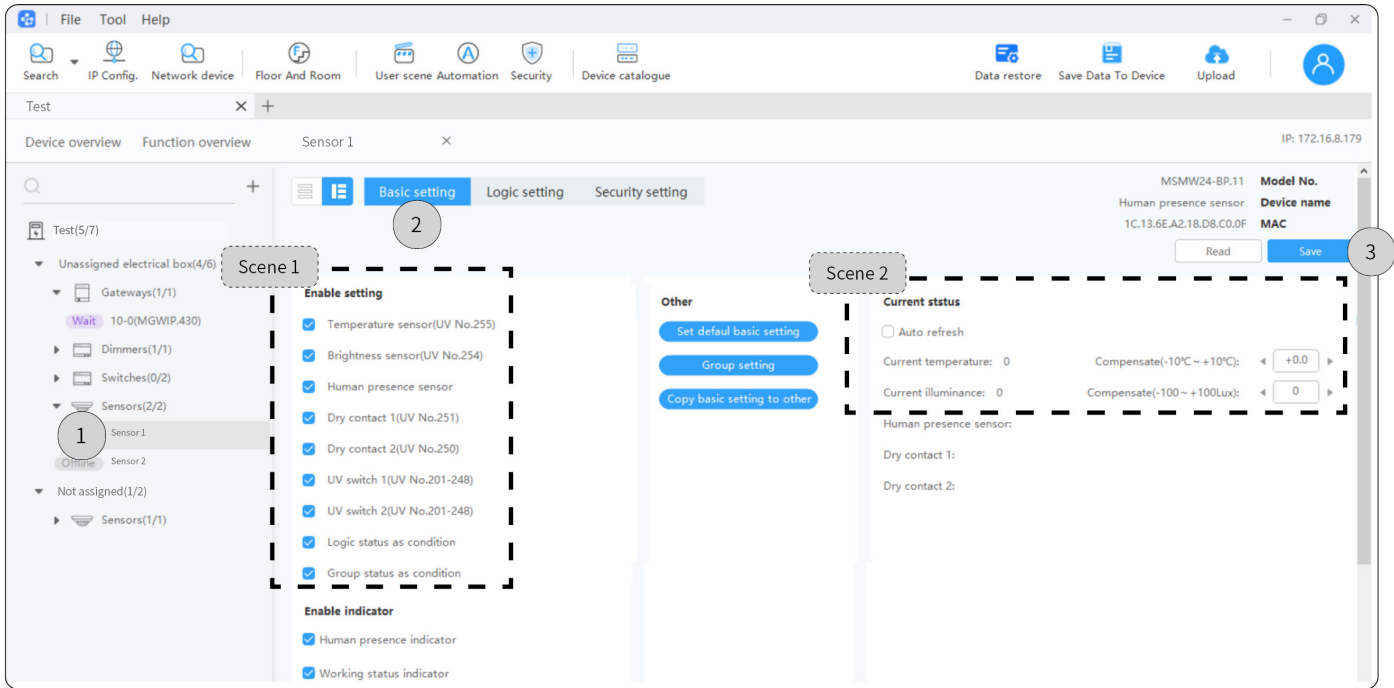

Scene 1 - Enable or Disable the basic function as below:

Tips: All basic functions are enabled by default. If users disable any of them, the corresponding one will stop running.

- Temperature sensor, brightness sensor, human presence sensor
- Dry contact 1, dry contact 2
- UV switch 1, UV switch 2
- Logic status as condition, group status as condition

Scene 2 - Compensate settings for current temperature and illuminance

- Temperature: Compensate range is -10°C~10°C, with degree of accuracy at 0.5°C.
- Illuminance: Compensate range is -100Lux~100Lux, with degree of accuracy at 10Lux.

Scene 3 - Enable or Disable indicator

1. Human presence indicator: When enabled, it will indicate according to the detection results.

- Human presence detected: Green light is on.
- Human presence not detected: Green light flashes once every 2s.
- Device abnormal: Red light is on.

2. Working status indicator: When enabled, it will indicate according to the running status of the device.

- Success: Green light quickly flashes for 2s then off, which indicates successful operation, such as successful firmware update.
- Failure or error: Red light quickly flashes for 2s then off, which indicates failed operation, such as failed firmware update.
- Device positioning: Red light quickly flashes for 10s then off.
- ID modification: Red light is on.
- Device upgrading: Red light slowly flashes.

Scene 4 - Settings for presence detection and micro motion detection

- Sensitivity: Sensitivity level for detection distance is at Level 10 by default. The level range is 1 - 10, with degree of accuracy at Level 1 (10%, i.e. ≤0.5m).
- Unnamed delay: It is at 30s by default. The delay range is 2-180s.

Tips: If the delay time is set as < 30s, the device will not be able to perform presence monitoring.

2. Logic Setting

Occupancy Sensor supports 24 logics. Users can customize the logic input conditions through commissioning software. This supports comprehensive logical judgment through human presence detection, temperature detection, illuminance detection, external dry contact signals, general switches, master-slave sensors, etc., to trigger the target function.

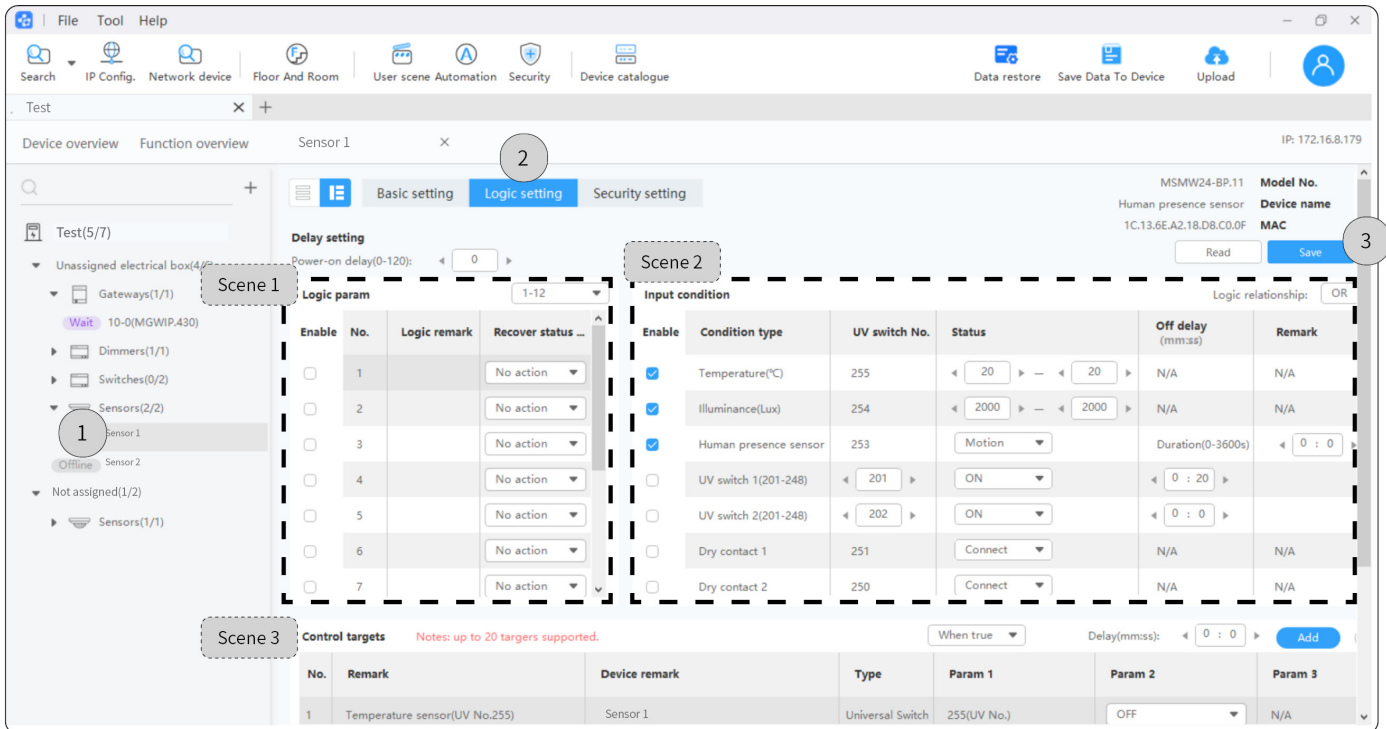

Scene 1 - Settings for logic parameter

- Logic remark
- Enable or Disable the logic selected
- Recover status setting for power off then on

Scene 2 - Input condition

- Temperature: > threshold value / < threshold value / within threshold range

- Illuminance: > threshold value / < threshold value / within threshold range
- Human presence sensor: Motion / No motion + Duration; Duration refers to how long the detected / undetected state lasts before the condition is met. If the duration is set to 0, it will be triggered immediately when human presence / no human presence is detected.
- 2 UV switches: On / Off (UV switch No. 201-248, which can be auto-off, with delay time range 0-3600s.)
- 2 Dry contacts: Break / Connect
- Logic relationship: AND /OR
- Customize logic condition: The pre-set logic can also be set as input condition.
- Group: Motion / No motion + Duration

Scene 3 - Control targets: Each logic can trigger up to 20 targets.

3. Security Setting

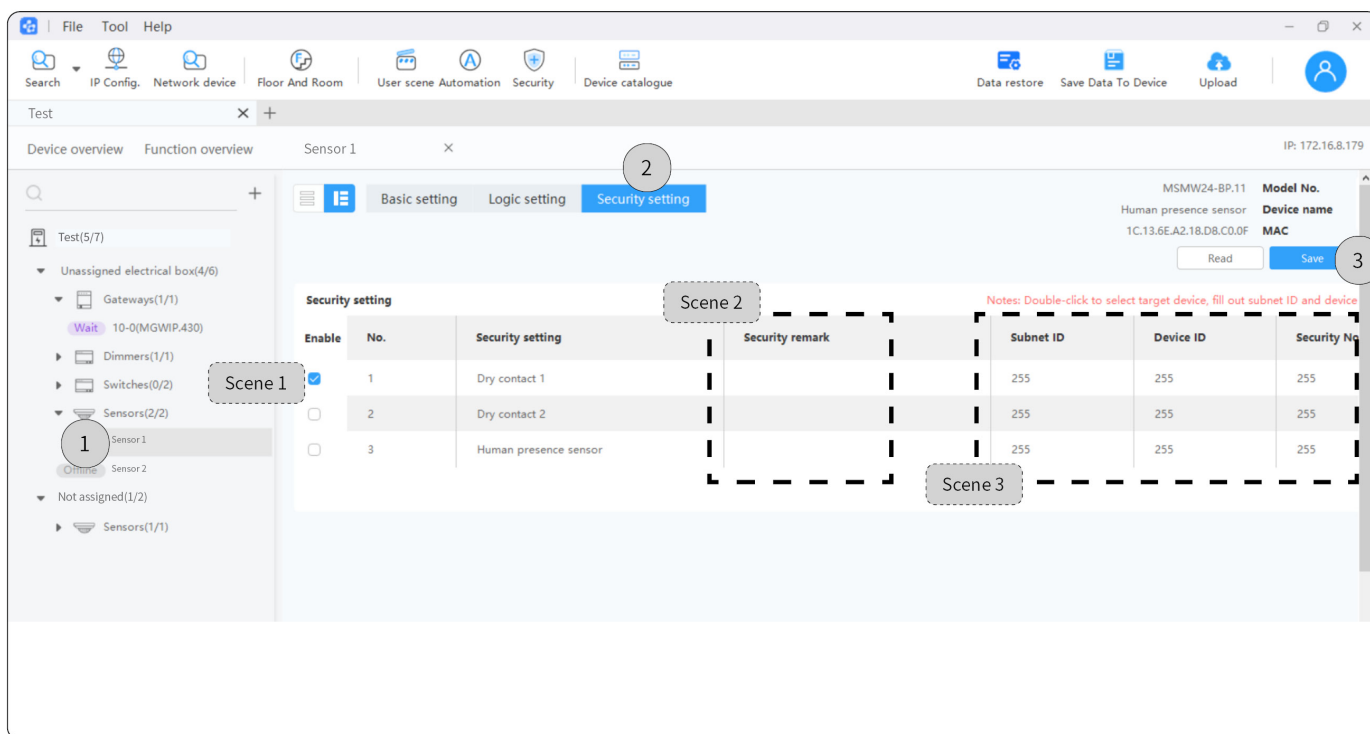

Step 1. Double click the tab of the occupancy sensor required to enter its setting page.

Step 2. Click "Security setting". As shown below, users can proceed security settings for the sensor, as shown in Scene 1~3.

Step 3. Click "Save" to complete.

Scene 1 - Enable or Disable human presence sensor, dry contact 1 and 2.

Scene 2 - Security remark

Scene 3 - Revise Subnet ID, Device ID and Security No.

4. Scene Setting

Step 1. Click "User scene" to enter the setting page. --> Step 2. Click "Add" to create scene.

Tips: To proceed further setting for the scene item, please right click and select.

Step 3. Click "Add" to create execute action.

Tips: To proceed further setting for the action, please right click and select.

Step 4. Click "Save" to complete.

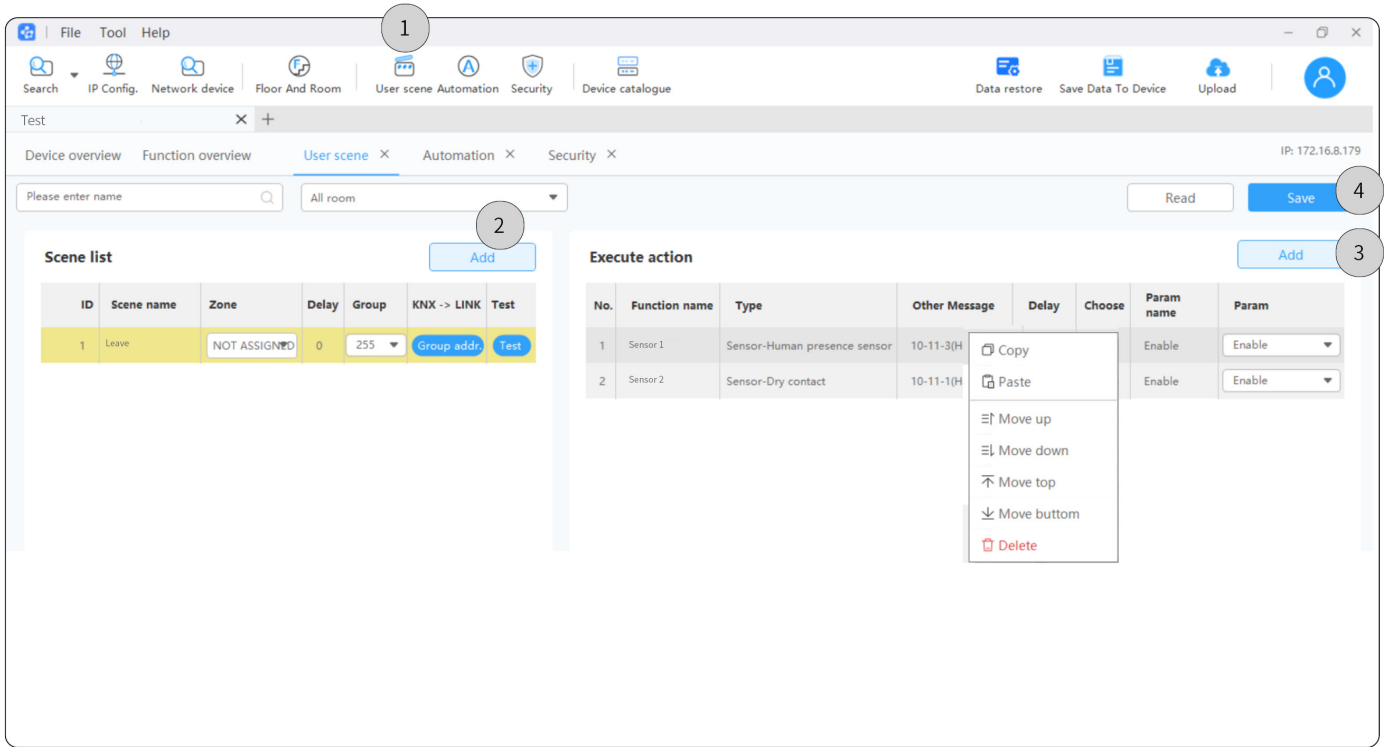

5. Automation Setting

Step 1. Click "Automation" to enter the setting page. --> Step 2. Click "Add" to create automation.

Tips: To proceed further setting for the automation item, please right click and select.

Step 3. Click "Add" to create the condition and repeat date. --> Step 4. Click "Add" to create execution action.

Tips: To proceed further setting for the items, please right click and select.

Step 5. Click "Save" to complete.

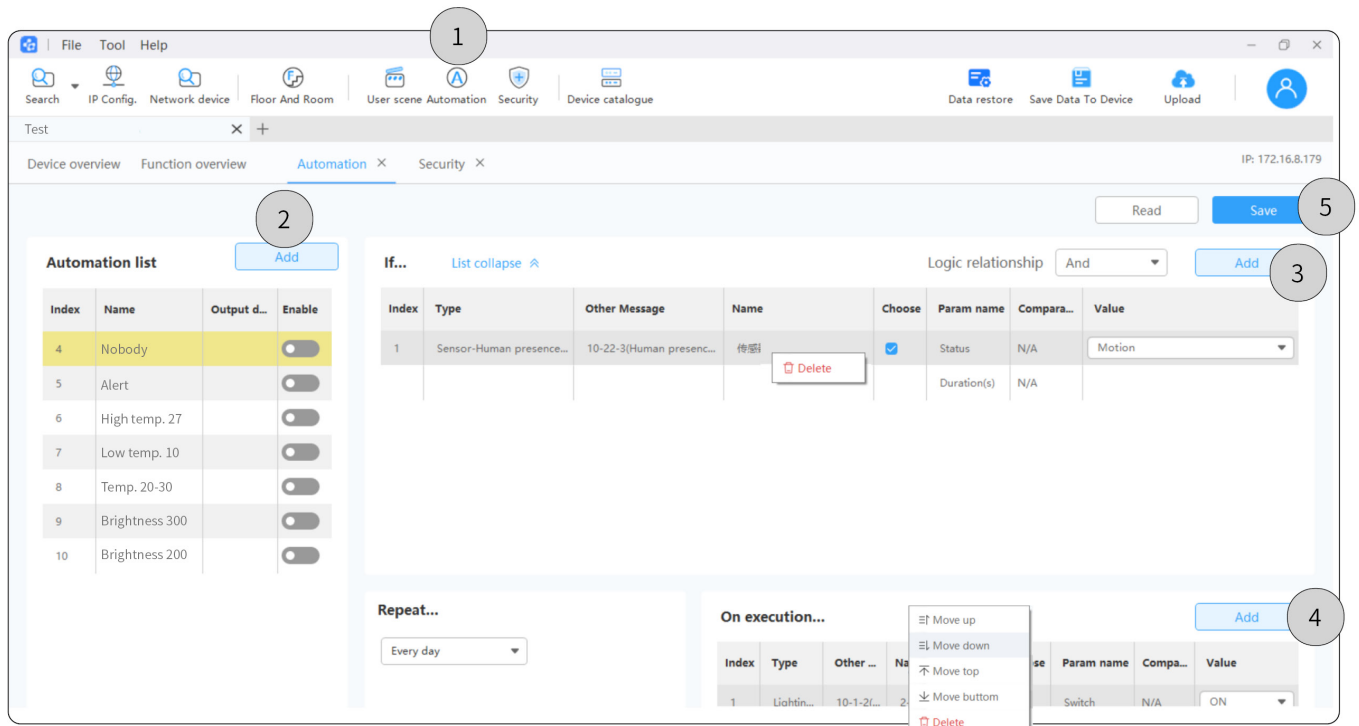

6. On Pro APP



6.1. Sensor Test

Step 1. Click "Category".

Step 2. Click "Function", here it shows all function bound with the current project, which have been already set by HDL Studio. Click the tab to enter the setting page. For instance, click "Sensor".

Scene 1 - Check the sensor list.

Scene 2 - View the detection results and logs of occupancy sensor.

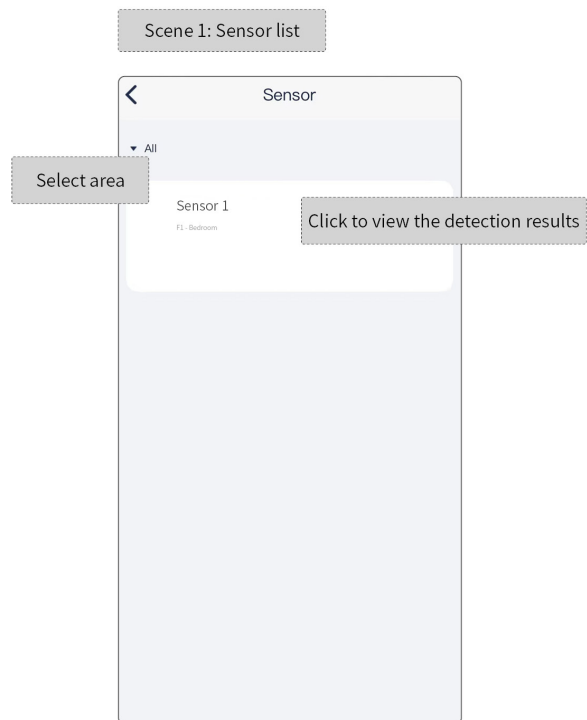
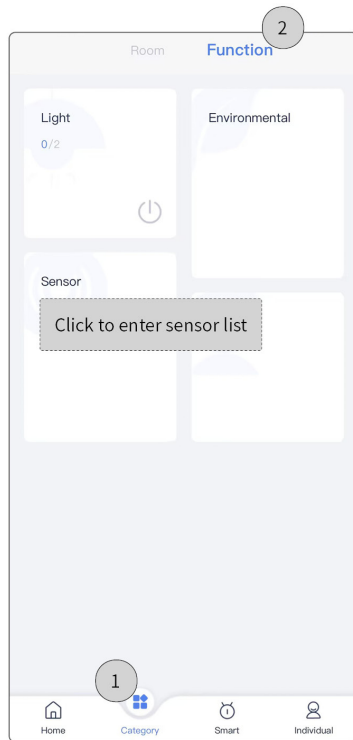

Scene 2: Detection results

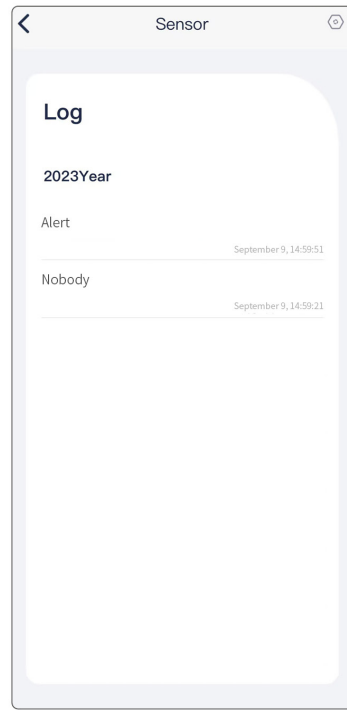
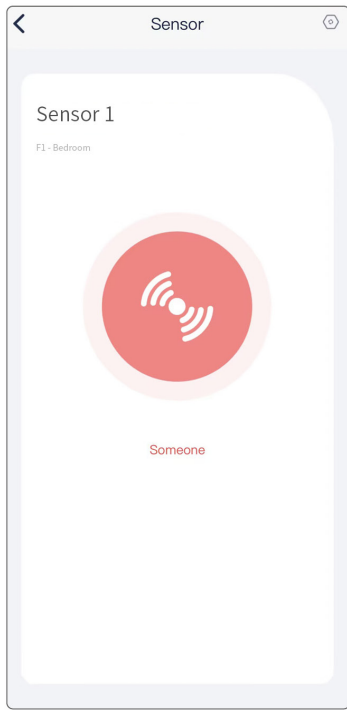

6.2. Automation Test

Step 1. Click "Smart".

Step 2. Click "Automation", here it shows all automation bound with the current project, which have been already set by HDL Studio. Click the tab to enter the automation setting page, as shown in Scene 1.

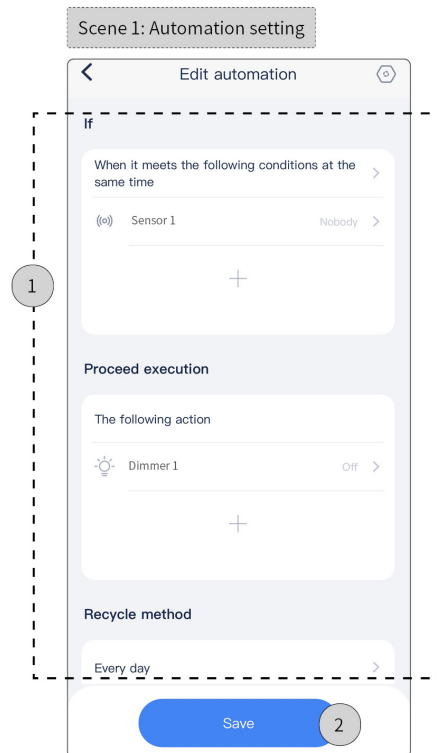
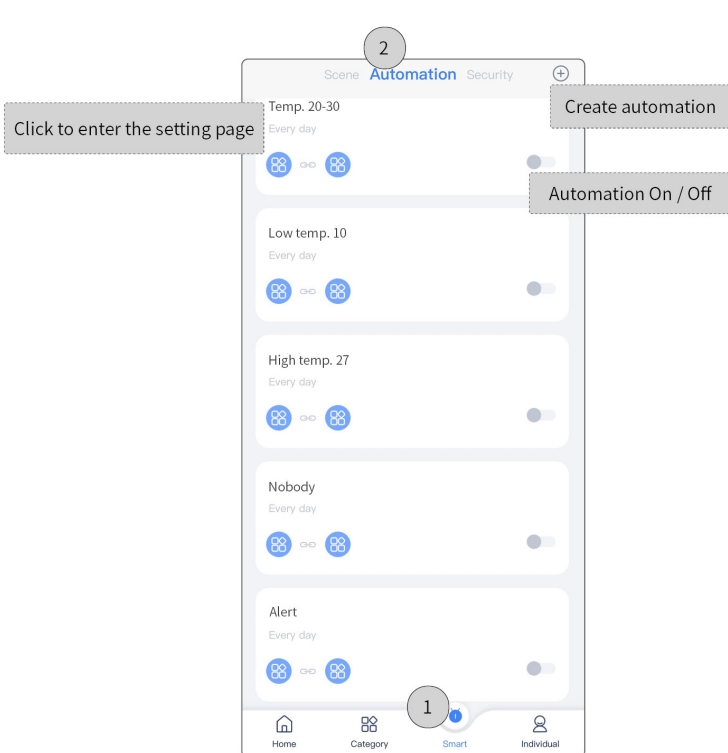

6.3. Security Test

Step 1. Click "Smart".

Step 2. Click "Security". Here users can customize the deployment setting, as shown in Scene 1. Or, users can adopt the fixed deployment and proceed further setting.

Tips: Delay time can be set in custom deployment, while for fixed deployment, there is no delay time setting. So, fixed

deployment is not influenced by disarming.

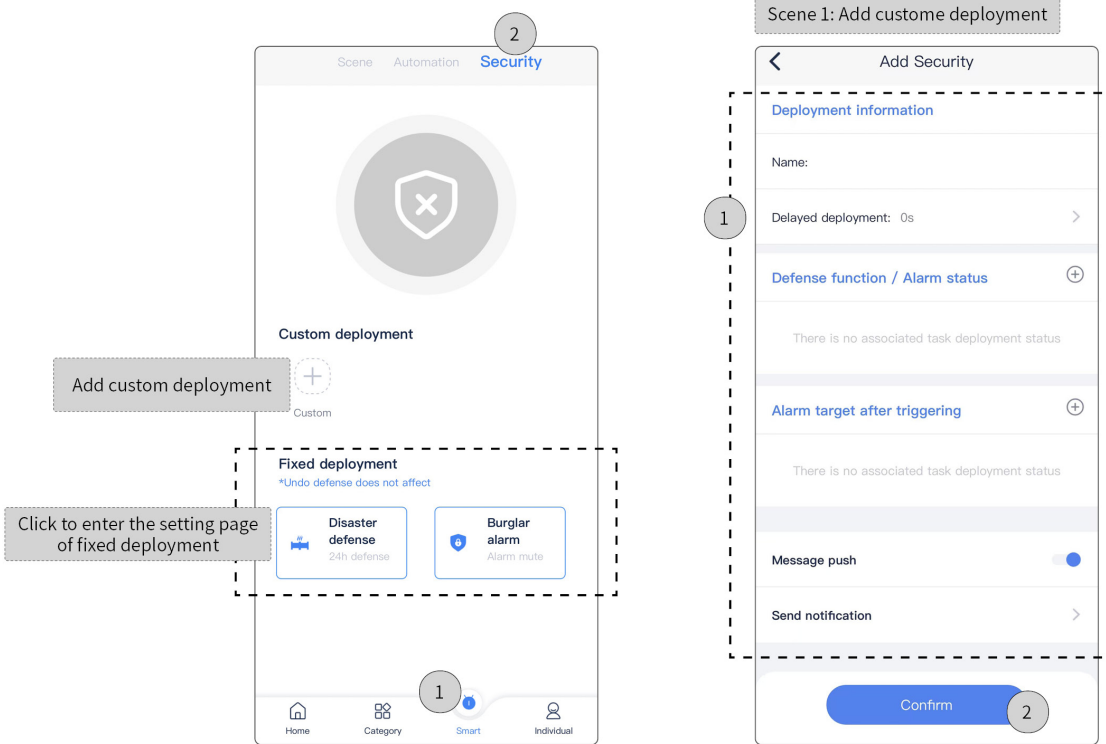

◆◆ Packing List

- Occupancy sensor (with the bracket for flush-mounted by default)*1
- Bottom cap (for surface-mounted)*1
- Screw (M3.5*40)*2
- QR code card*1

Note: After unpacking, please check if the product and the parts are complete.

◆◆ Legal Statemen

HDL has all the intellectual property rights to this document and contents thereof. Reproduction or distribution for third parties are prohibited without written authorization from HDL. Any infringement of HDL's intellectual property rights will be investigated the legal liability.

The contents of this document will be updated as the updates of product versions or other reasons. Unless otherwise agreed upon, this document is to be used as a guidance only. All the statements, information and recommendations in this document makes no warranty expressed or implied.

© 2023 HDL Automation Co., Ltd. All rights reserved.

Update History

The form below contains the information of every update. The latest version contains all the updates of all former versions.

Version	Update Information	Date
V1.0	Initial release	September 26, 2023
V1.1	Updated instructions for installation and commissioning.	November 9, 2023

--	--	--

◆◆ Technical Support

E-mail: hdtickets@hdlautomation.com

Website: <https://www.hdlautomation.com>